

# elica

EPBI 960 MMF  
Built-In Electric Oven  
User Manual

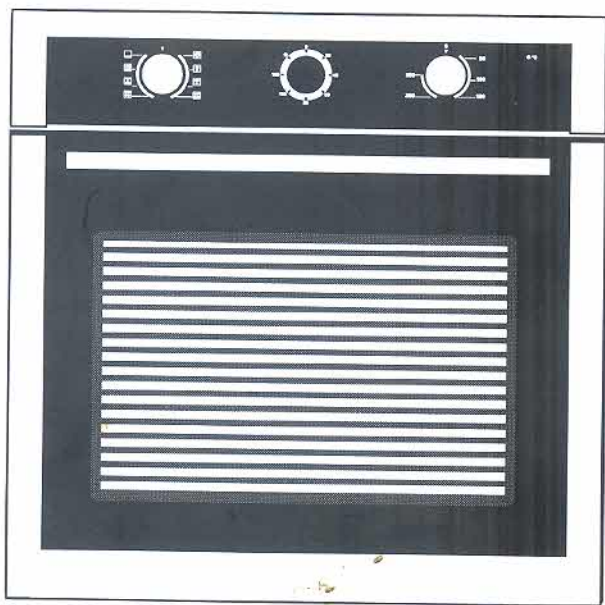

## **ACKNOWLEDGMENT**

Thank you for purchasing our product. We hope you enjoy using the many features and benefits it provides. Before using this product please study this entire Instruction Manual carefully. Keep this manual in a safe place for future reference. Ensure that other people using the product are familiar with these instructions as well.

## **WARNING**

**When the oven is first switched on, it may give off an unpleasant smell. This is due to the bonding agent used for the insulating panels within the oven. This is completely normal, if it does occur, you merely have wait for the smell to clear before putting food into the oven.**

- ◆ **The appliance and its accessible parts become hot during use.**
- ◆ **Care should be taken to avoid touching heating elements.**
- ◆ **Children less than 8 years of age shall be kept away unless continuously supervised.**
- ◆ **This appliance can be used by children aged from 8 years and above and persons with**

reduced physical, sensory or mental capabilities or lack of experience and knowledge if they have been given supervision or instruction concerning use of the appliance in a safe way and understand the hazards involved. Children shall not play with the appliance. Cleaning and user maintenance shall not be made by children without supervision.

- ◆ **Do not use harsh abrasive cleaners or sharp metal scrapers to clean the glass of the oven.** This can scratch the surface and may result in permanent damage to the glass.
- ◆ **During use, the appliance becomes very hot.** Care should be taken to avoid touching heating elements inside the oven.
- ◆ **Do not allow children to go near the oven when it is operating, especially when the grill is on.**
- ◆ **Ensure that the appliance is switched off before replacing the oven lamp to avoid the possibility of electric shock.**
- ◆ **The means for disconnection must be incorporated in the fixed wiring in accordance with the wiring specifications.**

- ◆ **Children should be supervised to ensure that they do not play with the appliance.**
- ◆ **This appliance is not intended for use by persons (including children) with reduced physical, sensory or mental capabilities, or lack of experience and knowledge, unless they have been given supervision or instruction concerning use of the appliance by person responsible for their safety.**

## SAFETY HINTS

- Do not use the oven unless you are wearing something on your feet. Do not touch the oven with wet or damp hands or feet.
- For oven: Oven door should not be opened often during the cooking period.
- The appliance must be installed by an authorized technician and put into use. The producer is not responsible for any damage that might be caused by defective placement, and installation by unauthorized personnel.
- When the door or drawer of oven is open do not leave anything on it, you may unbalance your appliance or break the door.
- Some parts of appliance may keep its heat for a long time; it is required to wait for it to cool down before touching onto the points that are exposed to the heat directly.
- If you will not use the appliance for a long time, it is advised to plug it off.
- If the supply cord is damaged, it must be replaced by the manufacturer, its service agent or similarly qualified persons in order to avoid a hazard.
- Excess spillage must be removed before cleaning and shall specify which utensils can be left in the oven during cleaning.
- Only use the temperature probe recommended for this oven.
- A steam cleaner is not to be used.

## FITTING THE OVEN INTO THE KITCHEN UNIT

Fit the oven into the space provided in the kitchen unit; it may be fitted underneath a work top or into an upright cupboard. Fix the oven in position by screwing into place, using the two fixing holes in the frame. To locate the fixing holes, open the oven door and look inside. To allow adequate ventilation, the measurements and distances adhered to when fixing the oven.

## IMPORTANT

If the oven is to work properly, the kitchen housing must be suitable. The panels of the kitchen unit that are next to the oven must be made of a heat resistant material. Ensure that the glues of units that are made of veneered wood can withstand temperatures of at least 120°C. Plastics or glues that cannot withstand such temperatures will melt and deform the unit, once the oven has been lodged inside the units, electrical parts must be completely insulated. This is a legal safety requirement. All guards must be firmly fixed into place so that it is impossible to remove them without using special tools. Remove the back of the kitchen unit to ensure an adequate current of air circulates around the oven. The hob must have a rear gap of at least 45 mm.

## DECLARATION OF COMPLIANCE

When you have unpacked the oven, make sure that it has not been damaged in any way. If you have any doubts at all, do not use it: contact a professionally qualified person. Keep packing materials such as plastic bags, polystyrene, or nails out of the reach of children because these are dangerous to children.



## HOW TO USE

- Stay on: For the oven to be used in the " ⏻ ". the food may catch fire if the cooking time is set too long. Close supervision is necessary during toasting and the time should not be set too long.  
NOTE: For cooking times which are under sixty minutes, first set to a longer time and then turn the switch back to the time you require.
- To set functions by turning the function knob to desired level.  
The oven will automatically start cooking after function, time and temperature are set.
- To set the time of cooking by turning the timer knob to desired time per your food cooking guide.  
After the cooking time is up, the unit will " Dong" to stop.
- To set the temperature by turning the temperature knob.  
If the unit is not in use, always set the knobs to "0".

## PRODUCT DESCRIPTION

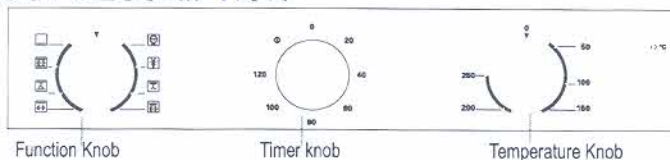

Function Knob

Timer knob

Temperature Knob

Symbol	Function description
	Oven Lamp: which enables the user to observe the progress of cooking without opening the door.
	Deforst: The circulation of air at room temperature enables quicker thawing of frozen food, (without the use of any heat). It's a gentle but quick way to speed up the defrosting time and thawing of ready-made dishes and cream filled produce etc.
	Bottom heat: A concealed element in the bottom of the oven provides a more concentrative heat to the base of food without browning. This is ideal for slow cooking dishes such as casseroles, stews, pastries and pizzas where a crispy base is desired. The temperature can be set within the range of 60-120°C. The default temperature is 60°C.
	Conventional cooking: The top and bottom work together to provide convectional cooking. The temperature can be set within the range of 50-250°C. The default temperature is 220°C. This is optional function that can be work with rotisserie motor.
	Convention with fan: Combination of the fan and both heating element provides more even heat penetration, saving up to 30-40% of energy. Dishes are lightly browned on the outside and still moist on the inside. Note: This function is suitable for grilling or roasting big pieces of meat at a higher temperature. The temperature can be set within the range of 50-250°C. The default temperature is 220°C.
	Radiant grilling: The inner grill element switches on and off to maintain temperature. The temperature can be set within the range of 180-240°C. The default temperature is 210°C. This is optional function that can be work with rotisserie motor.
	Double grill: The radiant heating element and the top heating element are working. The temperature can be set within the range of 180-240°C. The default temperature is 210°C.
	Double grill with fan: The radiant heating element and top heating element are working with fan. The temperature can be set within the range of 180-240°C. The default temperature is 210°C.

## ACCESSORIES

Wire shelves : For grill dishes, cake pan with items for roasting and grilling.



Universal pan: For cooking large quantities of food such as moist cakes, pastries, frozen food etc, or for collecting fat/ spillage and meat juices.



### SHELF PLACEMENT WARNING:

To ensure the oven shelves operate safely, correct placement of the shelves between the side rails is imperative. This will ensure that during careful removal of the shelf or tray, hot food items should not slide out.

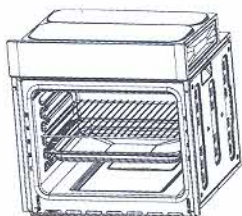

### USE OF ROTISSERIE ACCESSORIES

The rotisserie works in combination with the grill element to heat the food equally. At the same time, it can guarantee the nutrition of the food.

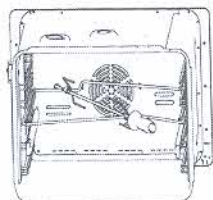

### SECURING THE OVEN TO THE CABINET

1. Fit oven into the cabinet recess.
2. Open the oven door.
3. Secure the oven to the kitchen cabinet with two distance holders "A" which fit the holes in the oven frame and fit the two wood screws "B".

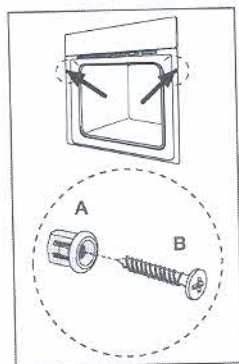

## BULB REPLACEMENT

The bulb in the light is a special bulb, and has high temperature resistance (240V~25W).

For replacement, proceed as follows:

- 1>.Disconnect power from the mains outlet or switch off the circuit breaker of the unit's mains outlet.
- 2>.Unscrew the covering glass and replace the bulb with a new one of the same type.
- 3>.Screw the covering glass back in place.



## VENTILATING OPENINGS

When cooking is finish, the cavity temperature is over 70 degree. The ventilating opening will continue working for 15 minutes after the oven stop cooking.

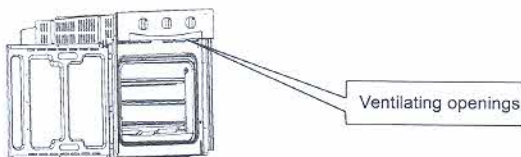

## CONNECTION OF THE OVEN

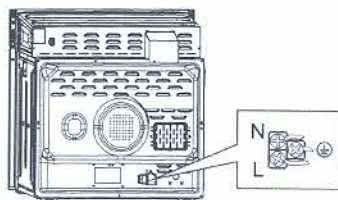

## INSTALLATION

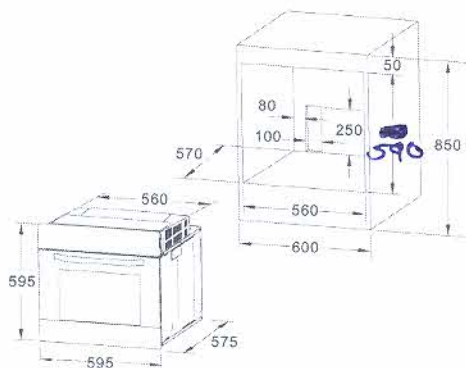

NOTE: The number of accessories included depends on the particular appliance purchased.



## CLEANING AND MAINTENANCE

For the sake of good appearance and reliability, keep the unit clean. The modern design of the unit facilitates maintenance to a minimum. The parts of the unit which come into contact with food have to be cleaned regularly.

- Before any maintenance and cleaning, disconnect the power.
- Set all controls in the OFF position.
- Wait until the inside of the unit is not hot but only slightly warm- cleaning is easier than when warm.
- Clean the surface of the unit with a damp cloth, soft brush or fine sponge and then wipe dry. In case of heavy soiling, use hot water with non- abrasive cleaning product.
- For cleaning the glass of the oven door, do not use abrasive cleaners or sharp metal scrapers, these can scratch the surface or lead to the glass being damaged.
- Never leave acidic substances (lemon juice, vinegar) on stainless steel parts.
- Do not use a high pressure cleaner for cleaning the unit. The baking pans may be washed in mild detergent.

This appliance is marked according to the European directive 2002/96/EC on Waste Electrical and Electronic Equipment(WEEE).

By ensuring this product is disposed correctly, you will help prevent potential negative consequences for the environment and human health, which could otherwise be caused by inappropriate waste handling of this product. The symbol on the product indicates that this product may not be treated as household waste. Instead it shall be handed over to the applicable collection point for the recycling of electrical and electronic equipment. Disposal must be carried out in accordance with local environmental regulations for waste disposal. For more detailed information about treatment, recovery and recycling of this product, please contact your local city office, your household waste disposal service or the shop where you purchased the product.

